

# ASSEMBLY INSTRUCTIONS

Tools Needed: Philips screwdriver or power drill (optional)

**CAUTION:** When assembling chair, **DO NOT** completely tighten the nuts and bolts until all the parts & holes are properly aligned and positioned.

## PARTS LIST

**IMPORTANT:** All Left & Right Side directions are from the perspective of looking at the front of the chair.

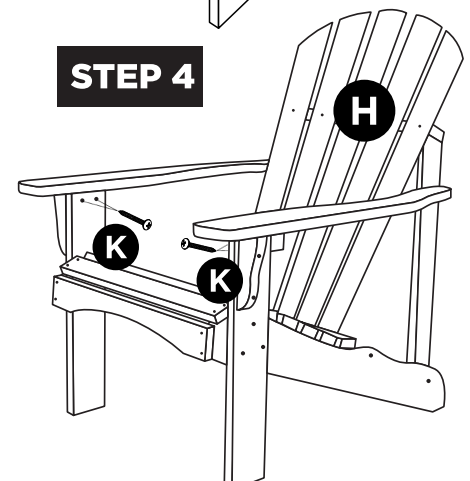
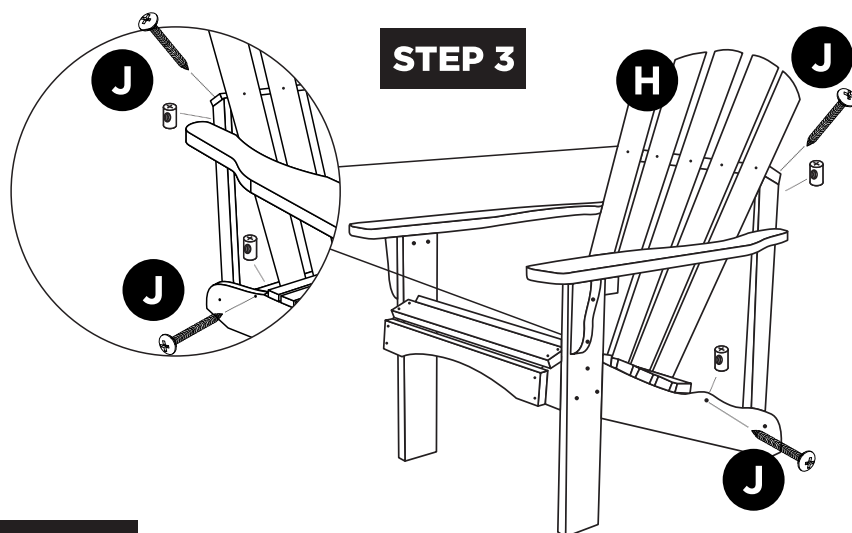
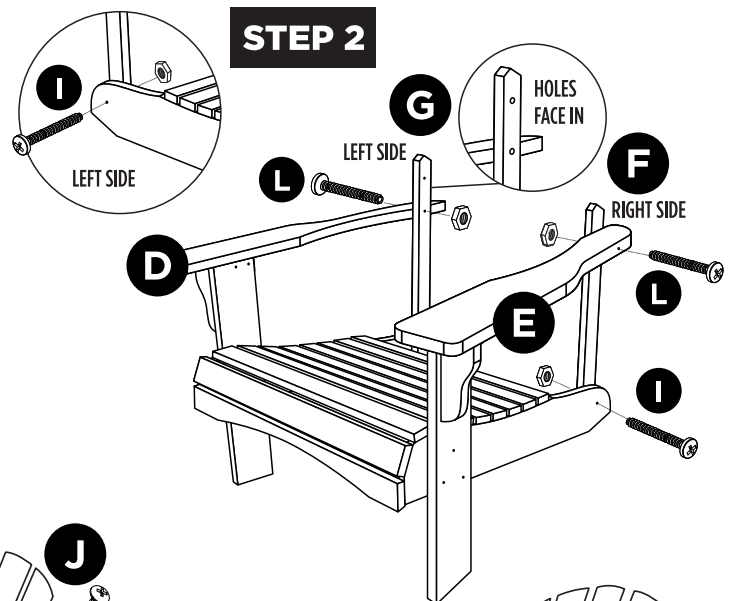
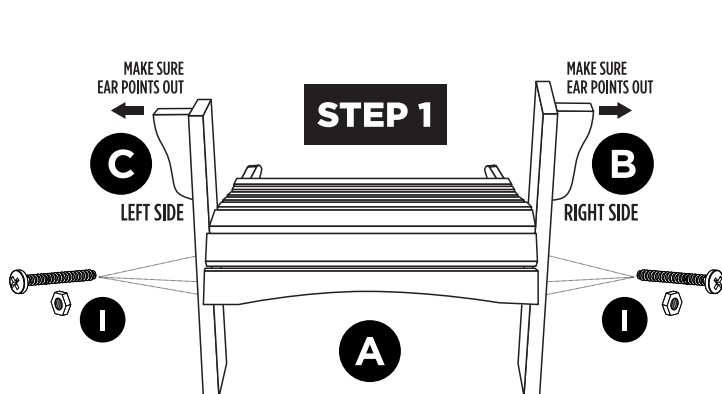
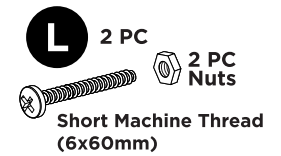
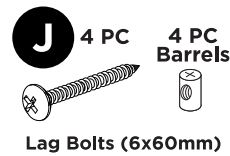
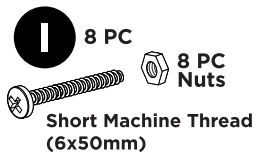
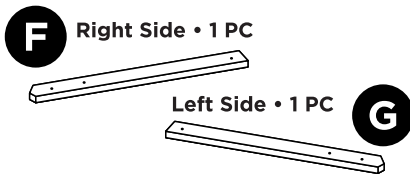
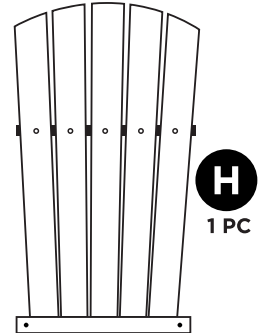
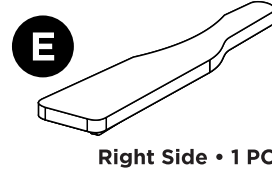
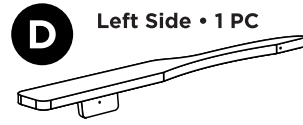
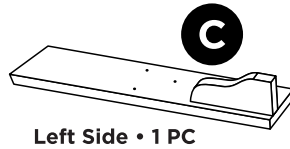
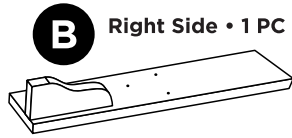
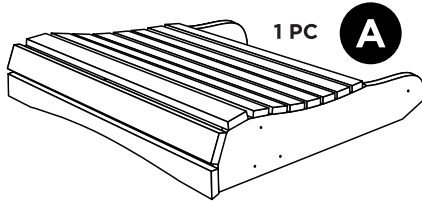

## STEP 5

**TIGHTEN ALL NUTS AND BOLTS WHEN YOU ARE COMPLETELY DONE ASSEMBLING THE CHAIR.**